

4

3

2

1

CROWN LINK[®]

專業薄膜開關連接器第一品牌

ROHS

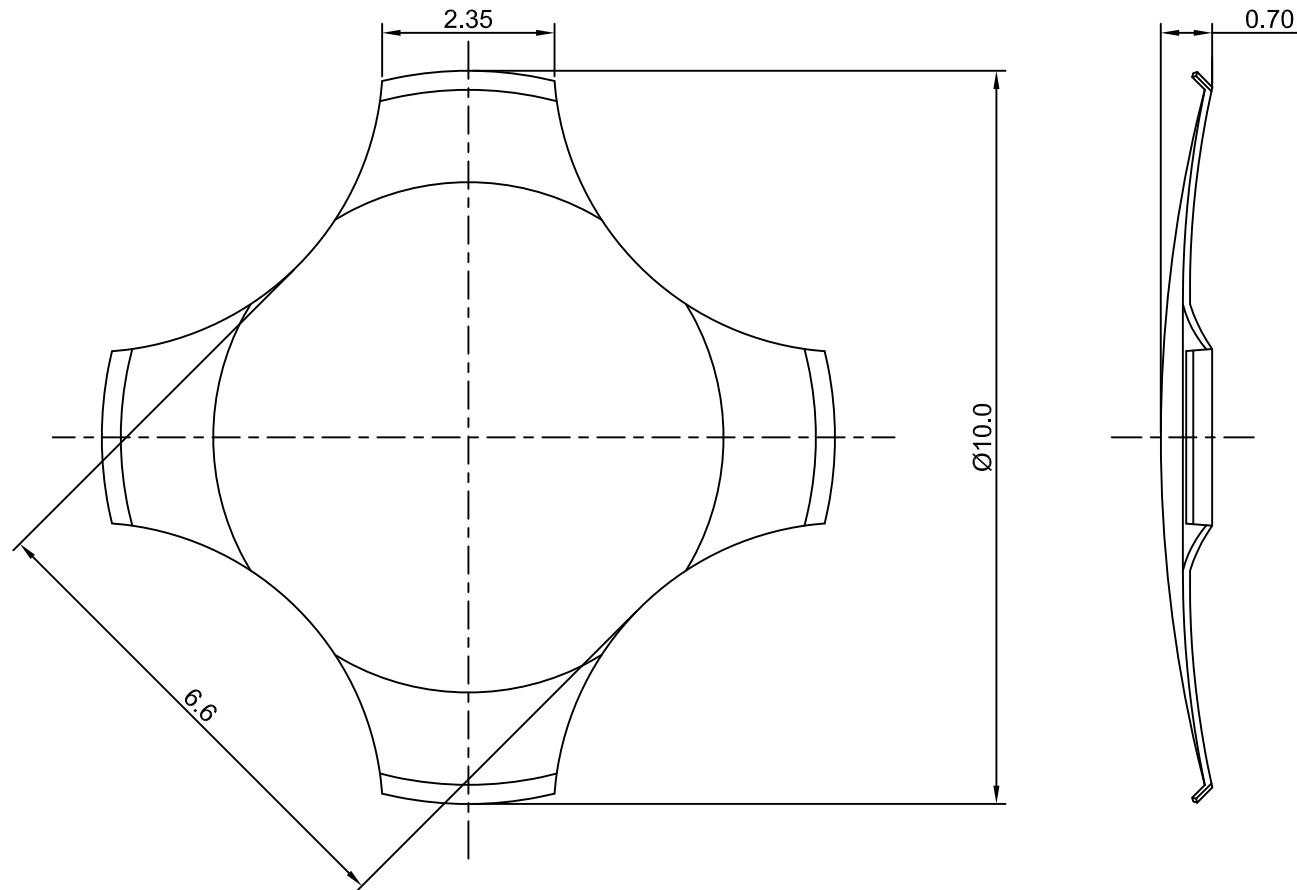

◆ SPECIFICATIONS

TRIP FORCE: 450 ± 30 g

CLICK RATIO: MIN 60 %

◆ TESTING CONDITIONS

FORCE TEST PROBE: HARD POINTED

LIFE TEST PROBE: RB 60° SILICON ROUND HEAD

LIFE TEST FORCE: 530 g

LIFE TEST SPEED: 180 CYCLE / MIN

BURR: MAX 0.05 MM

UNLESS OTHERWISE SPECIFIED TESTING METHOD

ACCORDING TO CROWNLINK STANDARD PROCEDURE

				X.XX ±0.10
B	NEW DRAWING FORMAT	ANNIE	2013.03.11	
A	FIRST DRAWING	ANNIE	2009.08.16	
REV/版本	MODIFIED CONTENT /變更內容	DRAWN/繪圖	DATE/日期	
				TOLERANCE RANGE/公差範圍

DRAWN/繪圖	DATE/日期	CROWN LINK[®] THE LEADING MANUFACTURER OF FPC & FFC CONNECTOR, HOUSING AND DOME.						
ANNIE	2013.03.11	PRODUCT NAME/品名 METAL DOME						
CHECK BY/審查	DATE/日期	PART NO./料號	THICKNESS/厚度	SCALE/比例	SIZE/圖號	UNIT/單位		
VIVIAN	2013.03.11	CL10-QSN-450T	0.10 mm	10:1	A4	mm		
APPROVED BY/核准	DATE/日期	MATERIAL/材質		ANGLE OF VIEW/視角	SHEET/頁碼	REV/版本		
JASON	2013.03.11	STAINLESS STEEL SUS 304		1 OF 1	1 OF 1	B		
PACKAGE/包裝	10,000PCS/BAG							

D

D

C

C

B

B

A

A