

4

3

2

1

# CROWN LINK®

## 專業薄膜開關連接器第一品牌

RoHS

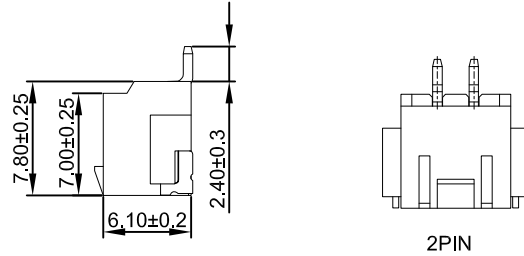
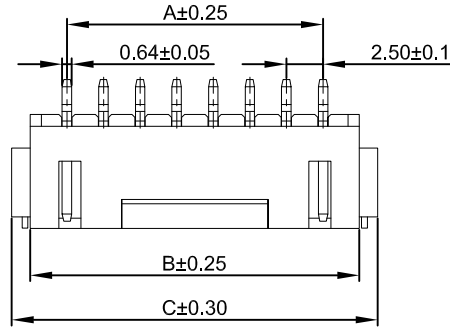

### ◆ SPECIFICATIONS

- VOLTAGE RATING: 500V AC, DC
- CURRENT RATING: 3 A AC, DC
- CONTACT RESISTANCE: 20mΩ MAX
- INSULATION RESISTANCE: 500 MΩ MIN
- WITHSTANDING VOLTAGE: 1000V AC / MINUTE

### ◆ ENVIRONMENTAL

- TEMPERATURE RANGE: -40°C~+105°C

### ◆ PART NO.

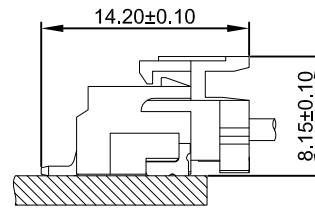
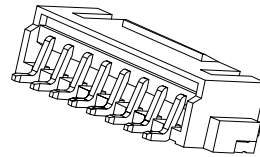
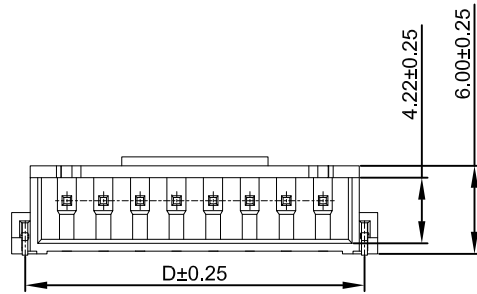
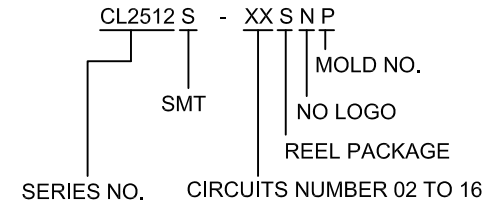

### ASSEMBLY LAYOUT

| PIN NO. | A     | B     | C     | D     | PIN NO. | A     | B     | C     | D     |
|---------|-------|-------|-------|-------|---------|-------|-------|-------|-------|
| 2       | 2.50  | 7.50  | 10.00 | 8.20  | 10      | 22.50 | 27.50 | 30.00 | 28.20 |
| 3       | 5.00  | 10.00 | 12.50 | 10.70 | 11      | 25.00 | 30.00 | 32.50 | 30.70 |
| 4       | 7.50  | 12.50 | 15.00 | 13.20 | 12      | 27.50 | 32.50 | 35.00 | 33.20 |
| 5       | 10.00 | 15.00 | 17.50 | 15.70 | 13      | 30.00 | 35.00 | 37.50 | 35.70 |
| 6       | 12.50 | 17.50 | 20.00 | 18.20 | 14      | 32.50 | 37.50 | 40.00 | 38.20 |
| 7       | 15.00 | 20.00 | 22.50 | 20.70 | 15      | 35.00 | 40.00 | 42.50 | 40.70 |
| 8       | 17.50 | 22.50 | 25.00 | 23.20 | 16      | 37.50 | 42.50 | 45.00 | 43.20 |
| 9       | 20.00 | 25.00 | 27.50 | 25.70 |         |       |       |       |       |

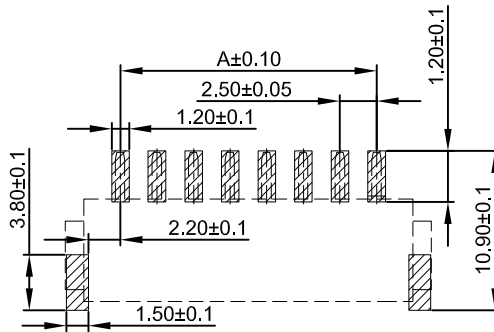

### P.C.B LAYOUT

|                |        |         |            |
|----------------|--------|---------|------------|
| DRAWN/繪圖       | JUDY   | DATE/日期 | 2022.10.19 |
| CHECK BY/審查    | VIVIAN | DATE/日期 | 2022.10.19 |
| APPROVED BY/核准 | JASON  | DATE/日期 | 2022.10.19 |
| PACKAGE/包裝     | REEL   |         |            |

|   |               |                  |          |         |  |
|---|---------------|------------------|----------|---------|--|
| <b>CROWN LINK® THE LEADING MANUFACTURER OF FPC &amp; FFC CONNECTOR, HOUSING AND DOME.</b> |               |                  |          |         |  |
| PRODUCT NAME/品名   |               |                  |          |         |  |
| 2.50mm XHB Wafer for Cable  |               |                  |          |         |  |
| PART NO./料號   | PIN NUMBER/針數 | SCALE/比例         | SIZE/圖號  | UNIT/單位 |  |
| CL2512S-XXSNP   | 02-16 PIN     | 2:1              | A4       | mm      |  |
| MATERIAL/材質   | COLOR/顏色      | ANGLE OF VIEW/視角 | SHEET/頁碼 | REV/版本  |  |
| Brass LCP UL94V-0   | NATURAL       |                  | 1 OF 1   | D       |  |

| REV/版本 | MODIFIED CONTENT /變更內容 | DRAWN/繪圖 | DATE/日期 |
|--------|------------------------|----------|---------|
|        |                        |          |         |

|                      |
|----------------------|
| TOLERANCE RANGE/公差範圍 |
|----------------------|

X ±0.50 X\* ±1\*  
 .X ±0.30 X\* ±0.1\*  
 .XX ±0.20 .XX\* ±0.01\*  
 .XXX ±0.05 .XXX\* ±0.005\*

D

C

B

A

D

C

B

A